

Domino

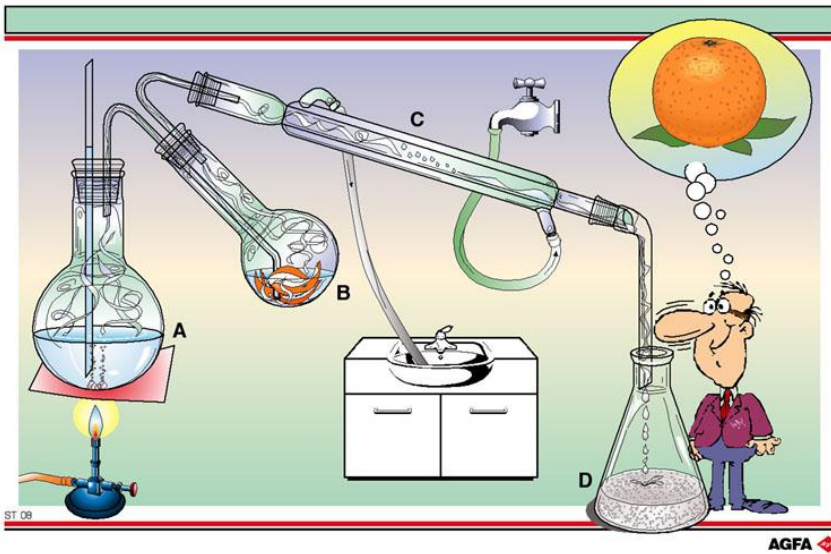

Filtratie

Domino

Zand van
stenen

Rook uit lucht

Domino

Aardappelen
afgieten



Domino

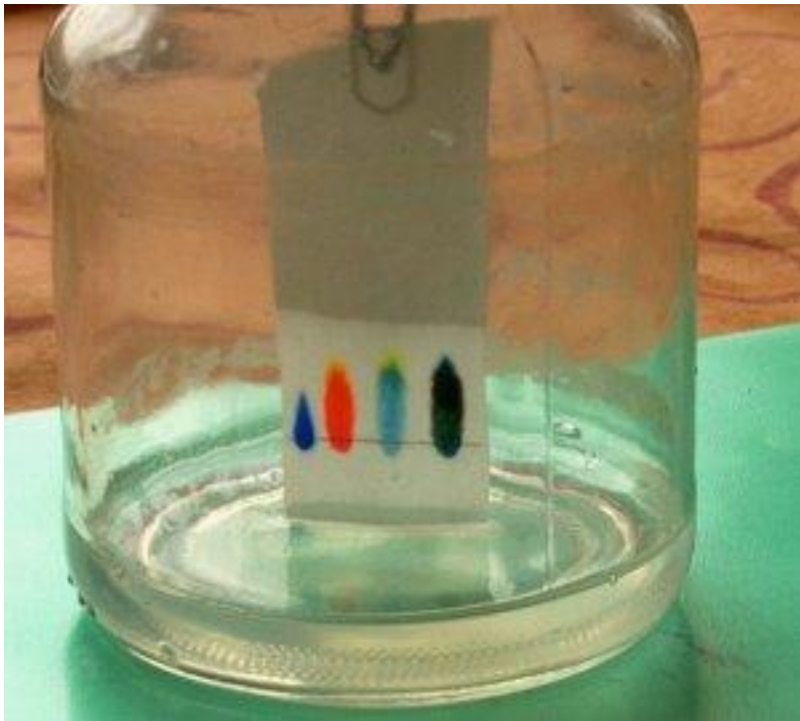

Domino

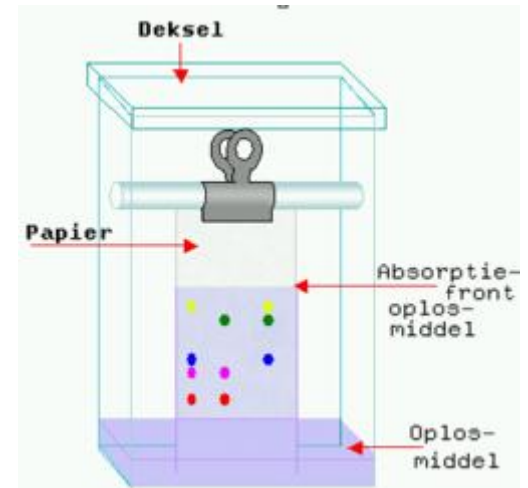

Domino

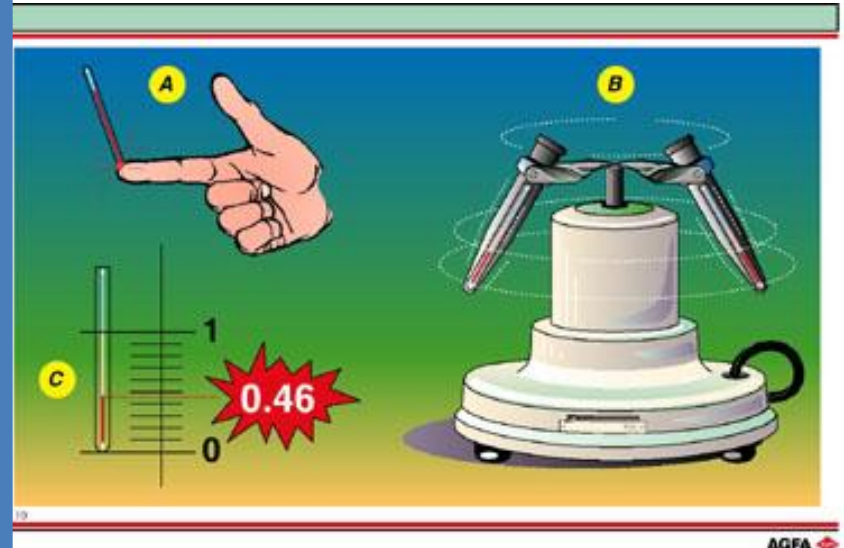
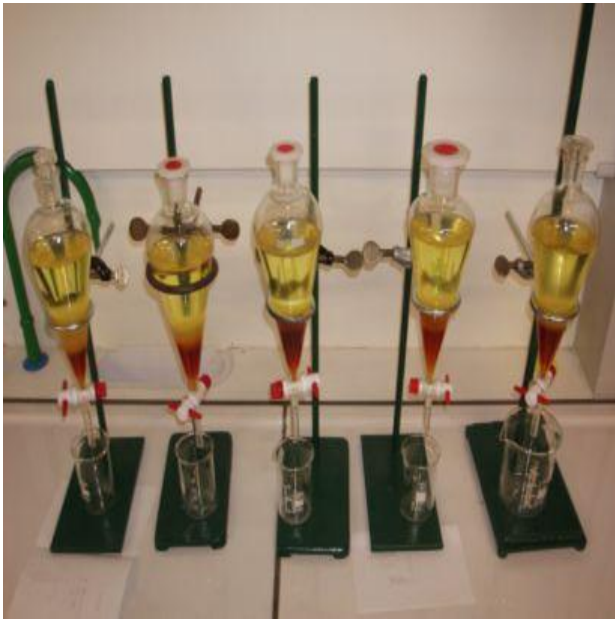

Domino

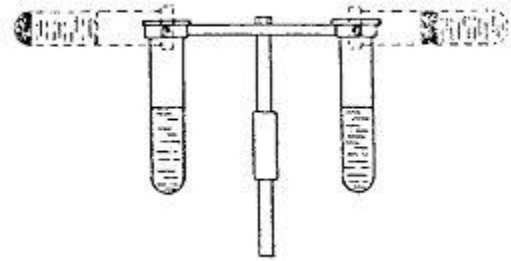

Domino



Domino



Domino

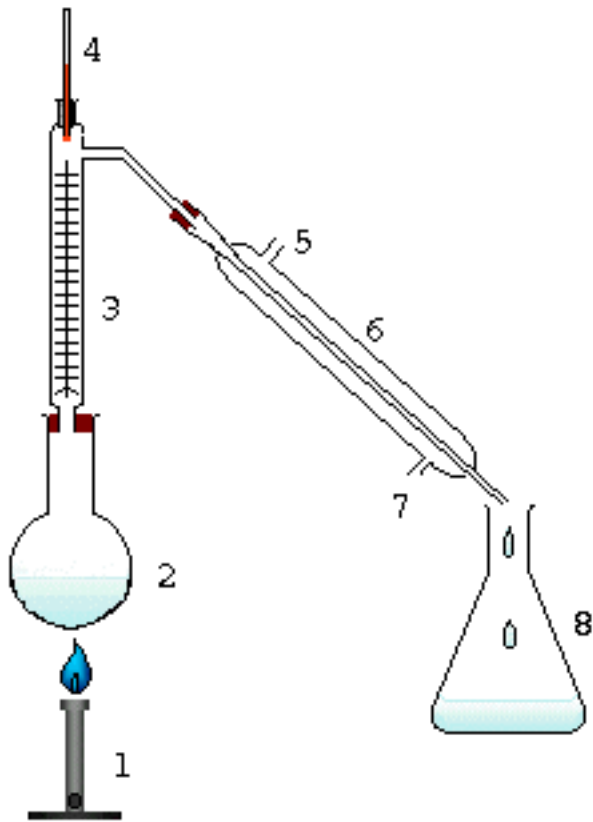

Domino



**Maken van
cognac**

Domino

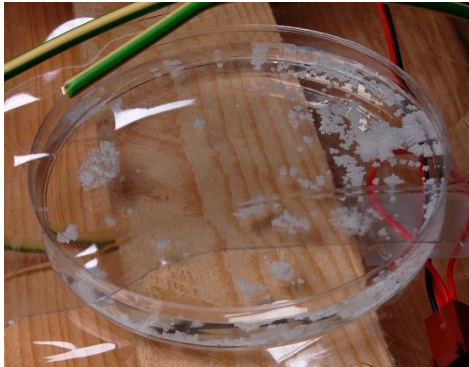

**Chlorofyl uit
bladeren**

Domino

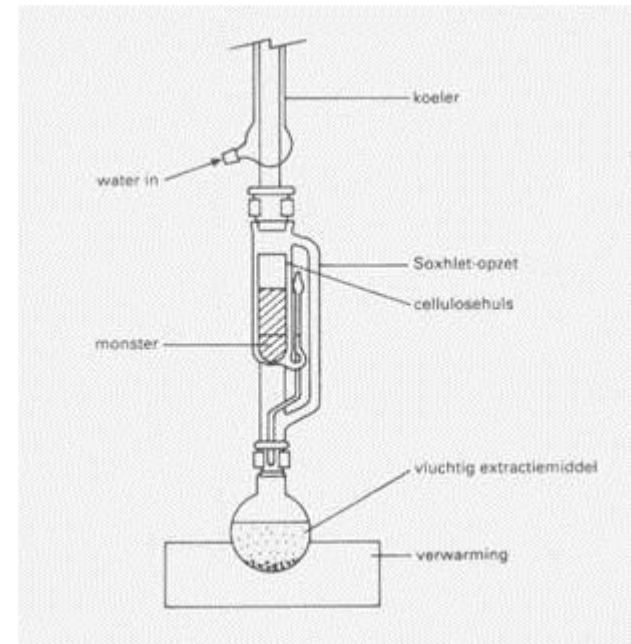
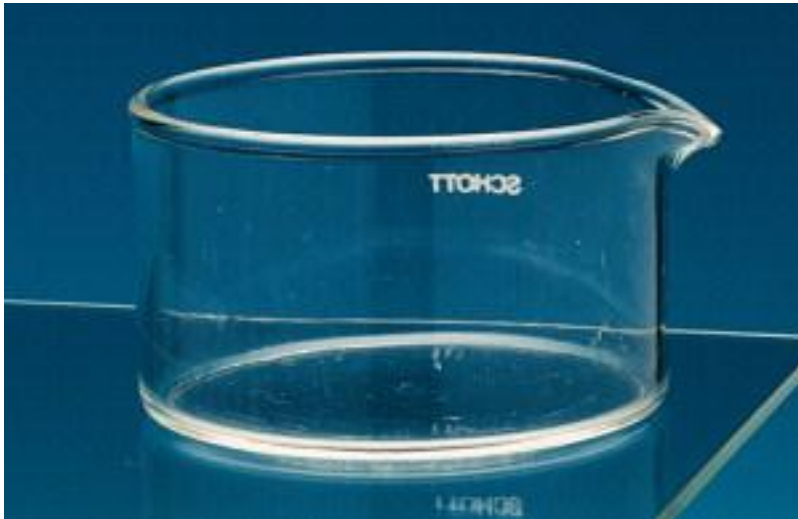

Domino



Domino



Domino



Domino

Was zwieren

Stenen zeven
van puim

Domino

Decantatie

centrifugatie

Domino

Extractie

Destillatie



Domino

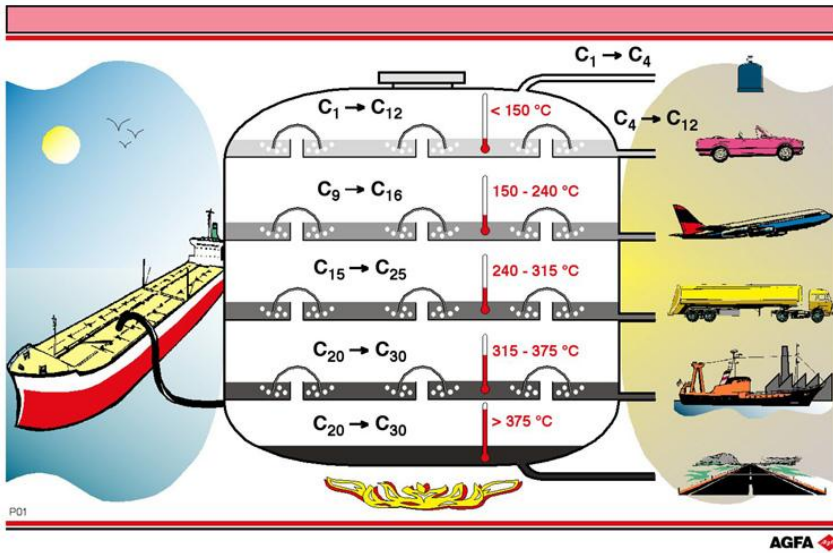

Substances to be separated dissolved in liquid

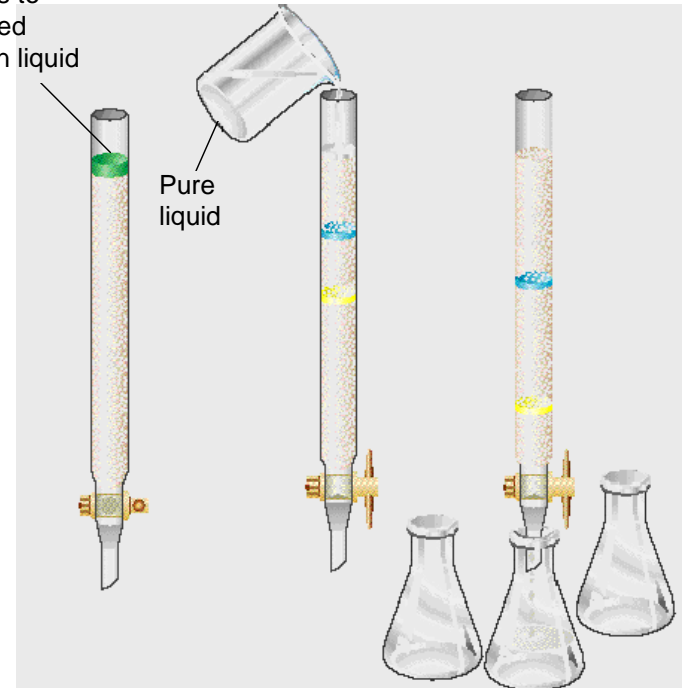

Domino

Kristallisatie

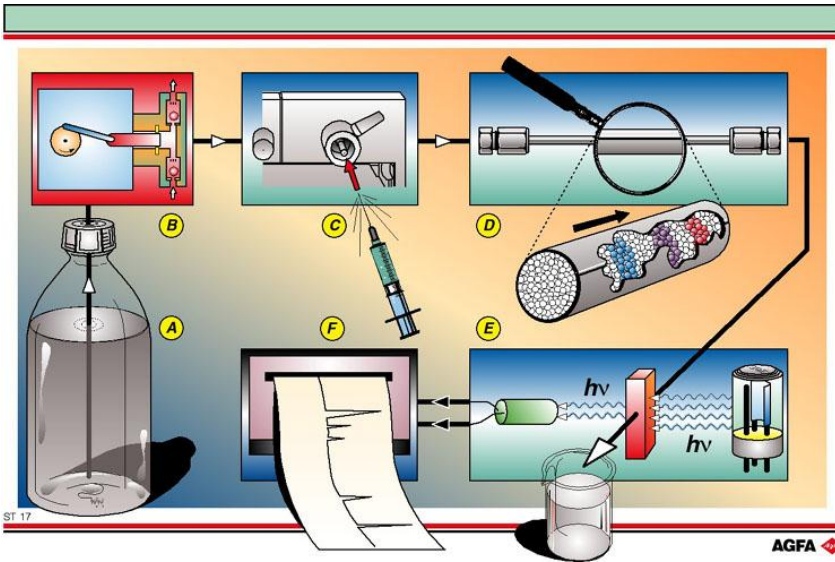

Domino

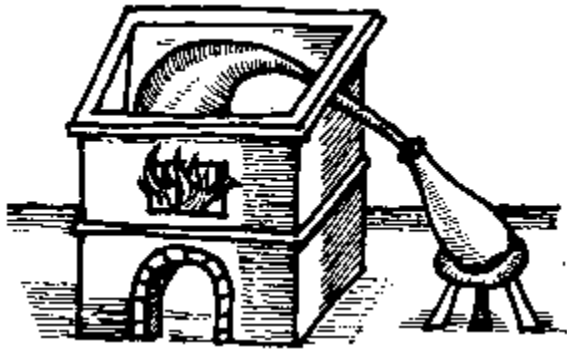

Zeven

Domino

Adsorptie

Chromatografie



Domino

**Verskil in
kookpunt**

**Verskil in
oplosbaarheid**

Domino

**Verskil in
dichtheid**

**Verskil in
grootte**

Domino

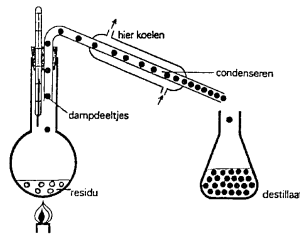

Verskil in
adsorptie-
capaciteit

Domino

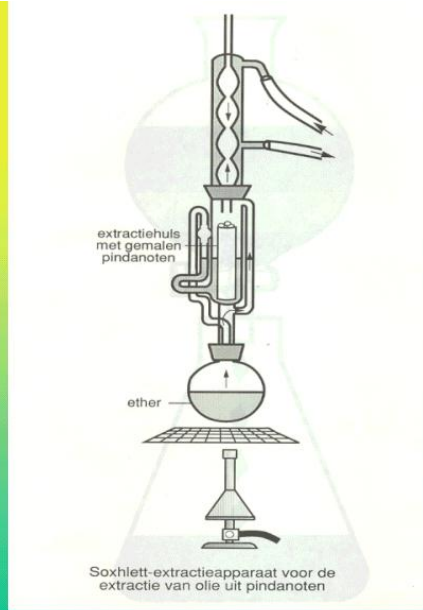

Domino

**Verschil in
dichtheid**

Grof mengsel

Domino



Domino



Domino

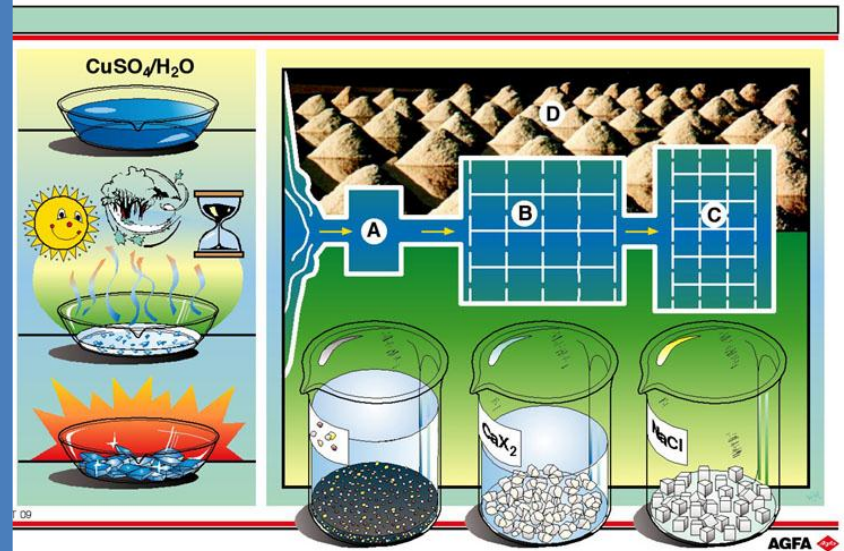

Domino

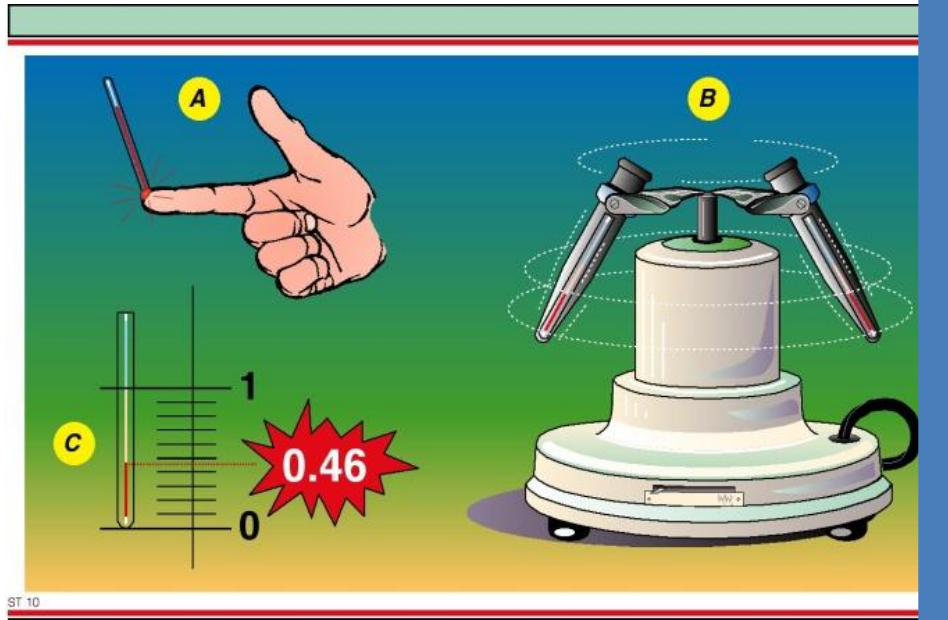

Domino

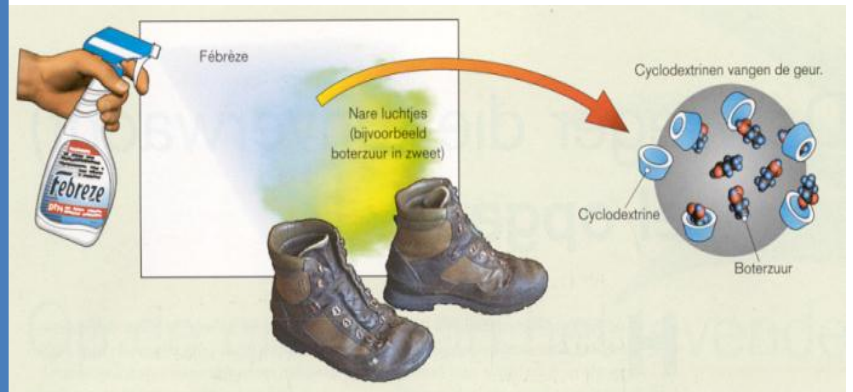

Domino

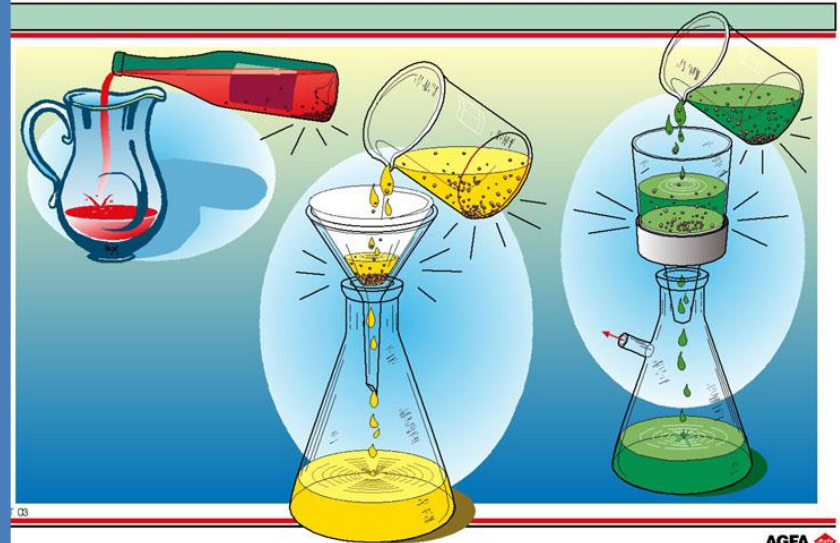
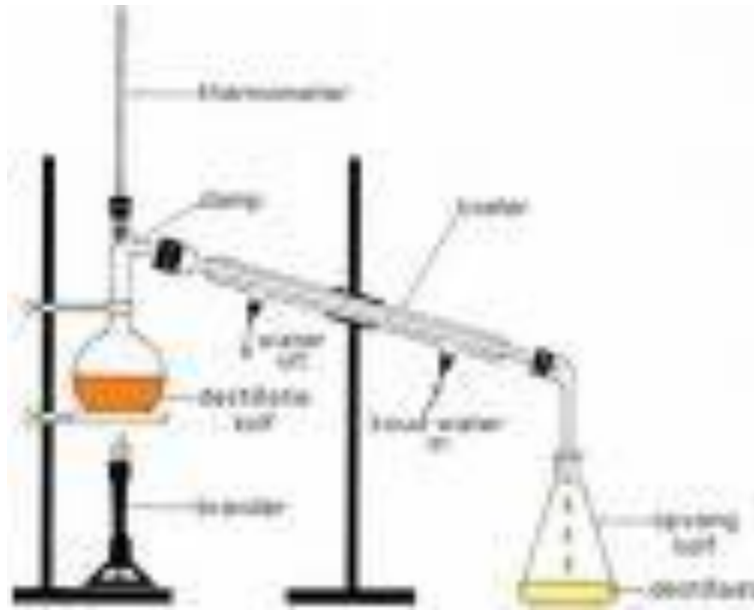

Domino

Water van zand

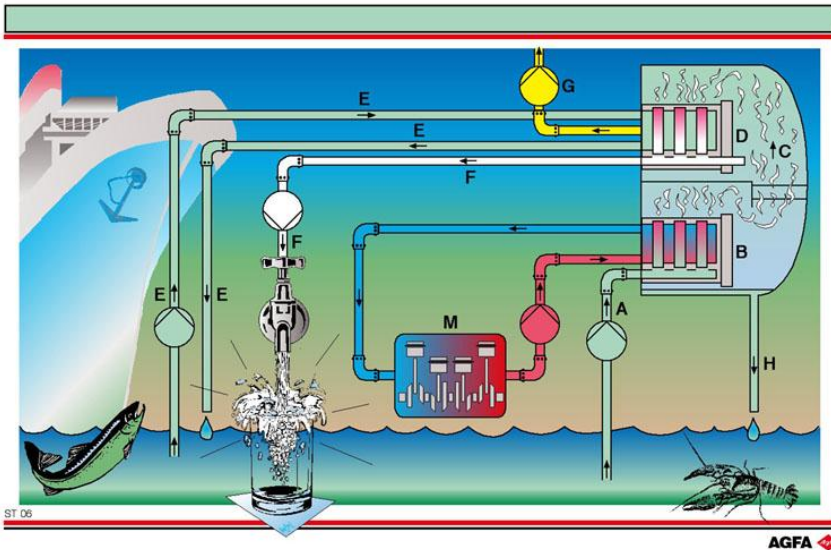

Domino

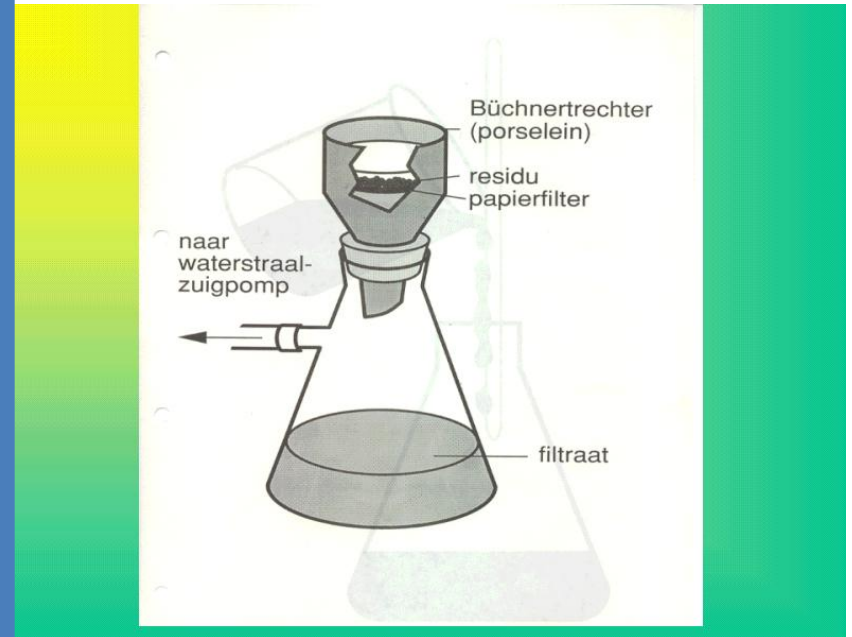
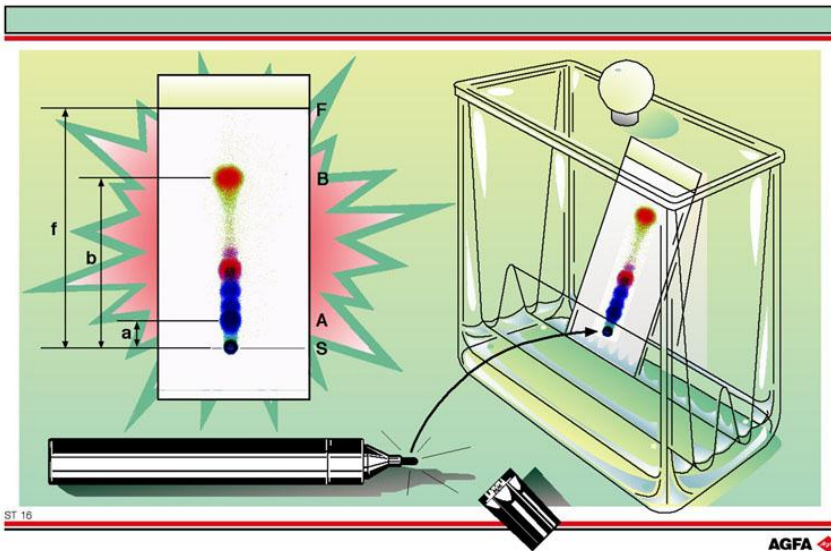

Domino

Filzschreiber
auf Startlinie

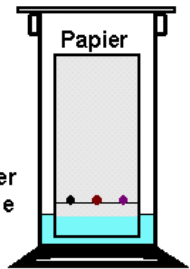

Ethanol/Wasser-
Gemisch

Papier/Wasser:
stationäre Phase

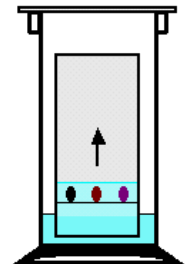

Das Papier saugt
sich voll Wasser

Farbstoffgemisch
trennt sich auf

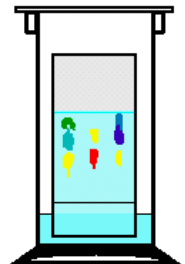

Die mobile Phase
wandert nach oben

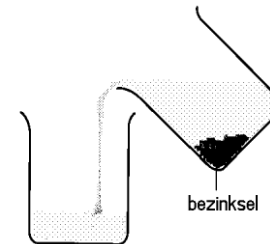

Domino

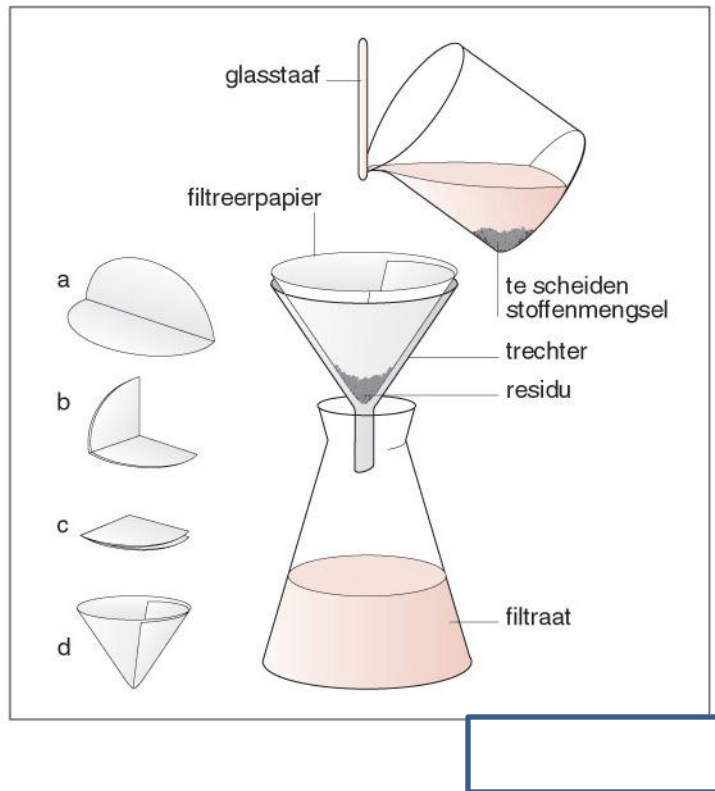

- Alcohol
- uit wijn

Domino

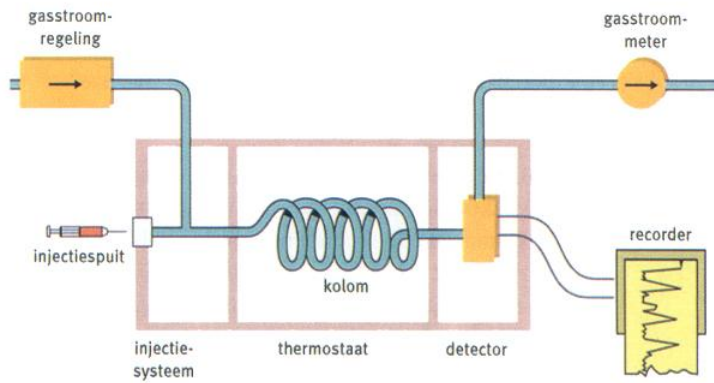

Domino

Olie van water

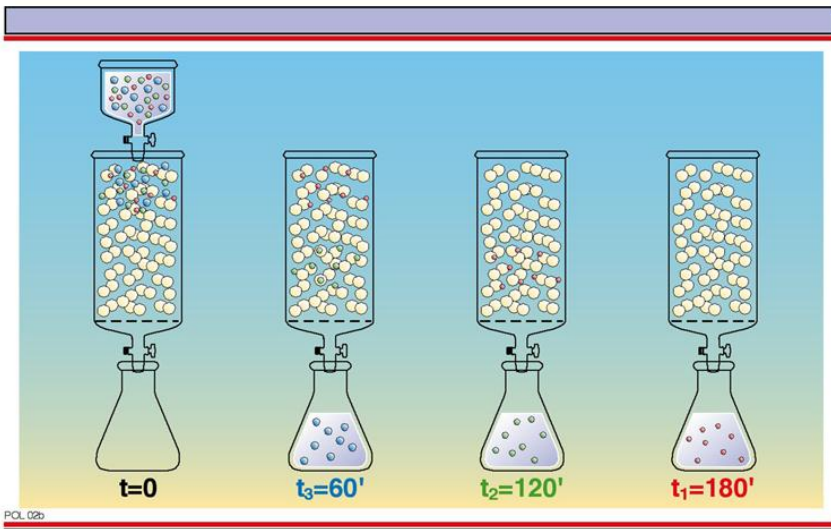

POL 02b